

Swimming Pool SPA & Outdoor SPA

User's manual
Installation & Operation



▲ Important tips:
Please read this manual before installation.
The manual provided with important product safety information.
Please keep it carefully.

Version2020-03

Welcome

Congratulates you make a wise decisionWarmly welcometo join
the increasingly powerful HOME SPA and enjoy the best Spa experience.

User's manual

This "user's manual" will allow you to be familiar with the operation and maintenance of the new spa. We suggest that you take time to read all the chapters carefully. Please keep it carefully for use in future.

If you have any questions about the installation, operation and maintenance of the spa, please contact authorized dealers. They are all trained professionals and familiar with the products and understand the concerns of new users. Their expertise will allow you to enjoy the comfort of the spa.

Serial number/identification label is located on the spa equipment cabin. At the same time, the serial number should be recorded on the delivery receipt provided by the dealer. Important note: our company has the right to change the specifications or design of the products without prior notice, and does not assume any responsibility.

Purchase date: _____

Installation Date: _____

Dealer: _____

Address: _____

Phone: _____

Spa type/serial number: _____

Cover serial number: _____

In most cities and countries, you need to get a permission to install electrical circuits or to construct outdoor buildings such as platforms and gazebos. In additional, some communities also implement residential barrier regulations and require constructing residential buildings of the wall and / or self- closing door for the house to prevent that the children under 5 years enter into spa in the unattended case. Spa is equipped with a lockable cover which complies with "Safety Covers Standard" ASTM F1346-91 and usually does no longer require residential barrier. Under normal circumstances, when you get the circuit installation permission, the local building department will inform you the provisions of the applicable barrier. Dealers will tell you which permissions you need

Contents

Safety guidelines

- How to use safety..... 1
- Important guide lines for using Spa.....2

Installation

- preparation of installation site..... 3
- preparation for Spa leveling.....4
- Cover installation.....4

Electrical installation

- Electrical requirements and precautionary measures.....5
- Cable duct installation instructions5
- Wiring regulations.....5
- Powerline connection figure..... 6

Control device and equipment

- Product functions.....7
- Configuration table.....7

Start and adding water

procedure..... 8

Customize your massage mode

- Diverter valve.....9
- Waterfall valve.....9
- Perfume box valve..... 9
- Air regulating valve..... 9
- Hydrotherapy nozzle..... 10
- Directional adjusting nozzle..... 10
- Directional rotating nozzle.....10
- Directional adjusting rotating nozzle.....10
- Bi-directional pulse rotating nozzle..... 10
- Air nozzle..... 10

Nozzle menu 11

Equipment cabin

- Side view of jet pump..... 12
- Side view of control device..... 12

Maintenance

- Disassembly and installation of filtration system..... 13
- Filter maintenance..... 13
- Filter core cleaning instructions..... 13

- Diverter valve maintenance..... 14
- Nozzle Maintenance..... 14
- Speaker operation..... 14
- Perfume replacement..... 14
- Water draining..... 15
- Winter preparation..... 15
- Winter preparation measures..... 15
- Pillow maintenance..... 16
- Exterior coating maintenance..... 16
- Spa tub skirt maintenance..... 17
- Spa cover maintenance..... 17
- Spa water maintenance..... 17

Water quality and maintenance

- General information..... 17
- Water test method..... 18
- Water quality maintenance program..... 19
- Water treatment system..... 20
- Chloride (sodium bichloride).....21
- Water treatment guidelines.....21
- Water quality maintenance supplementary program.....22
- Ozone system.....22-23
- General problems about the water chemical properties.....24
- Terms related to water..... 24-25
- Guide for problem solving in Spa water
- Water quality maintenance..... 25

Spa problem resolution

- Guide for troubleshooting in general operations.....26-27

Service

- Other service information..... 28
- Behaviors leading to invalid warranty..... 28
- Disclaimer.....28
- Customer service..... 28

Guide for operation system

- instructions.....29

Safety guidelines

How to use safety

Please read the following guidelines and carry out the operation according to all of the instructions to avoid safety accidents

⚠Dangers:

- Prevent children from privately entering into the Spa. Ensure that children enter into the Spa and use the massage function under the close monitoring of the adults in the full duration, in order to avoid any accident.
- When replacing the water pumps and related components, the new parts should be consistent with the original specifications, in order to prevent from the damage to the human body caused by the change of flow rate.
- In order to avoid the risk of electric shock, please do not put any metal piece within the range of 1.5 meters around the massage pool, unless the metal piece surface is permanently grounded with a single wire with a section area over 10 mm (28AWG), and the solid core copper grounding wires are connected to a cable connector of the grounded box, otherwise, the Spa can be installed in a place 1.5 meters away from the metal surface.
- Placement of any electronic device such as electric light, telephone, radio or television within 1.5 m from the Spa is forbidden. If the safe distance between the above mentioned electronic devices and the Spa is not kept and the electronic device falls into the Spa, this may lead to death or serious injury.

⚠Warning:

- In order to reduce the risk of electric shock, broken wires should be replaced immediately. Otherwise, the electric shock may lead to death or serious injury.
- Before each use of the spa, please check the ground fault circuit breaker. If the ground fault circuit breaker cannot operate normally, the leakage of ground current may cause electric shock to people. In this case, please disconnect the power supply, until the fault is determined and repaired.
- Before entering into the spa, the water temperature should be measured. The water temperature in the spa may not exceed 40 °C (104°F). For healthy adults, the temperature of 38 °C-40 °C (100°F-104°F) is safe. For babies, a slightly lower water temperature is more appropriate, when using the spa for more than 10 minutes. For pregnant women or women who may become pregnant, the temperature should be controlled under 38 °C (100°F). The human body is exhausted and the force is not left.
- Long time soaking in hot water can result in high body temperature, the symptoms of which include non-predictability of danger, for example: water burns can be caused without sensing the heating, the human body is exhausted and unable to leave the massage pool as well as unconsciousness that can result in drowning.
- Drinking alcoholic beverages or taking medicines before or during using the spa may lead to unconsciousness and cause accidents.
- Before using the spa, the patients taking medicines for long time due to heart disease, circulatory system disorders or pregnant women as well as the people taking medicines must firstly take the consultation from a doctor.
- The people taking the medicines with sleepy ingredients, especially the tranquilizers, antihistamines and anticoagulants are not allowed to use the spa.
- Before using the spa, the obese patients and the patients with high or low blood pressure, blood circulatory system diseases and the diabetic patients, or the patients having the history of heart disease must firstly take the consultation from a doctor.
- Risk of slipping and falling exists. Please remember and remind the people around you, that the wet surface is slippery and entering into the spa and stepping out of the spa must be very carefully.
- Please don't use the spa alone.
- Please take shower before and after using the spa. In order to reduce the possible spread of the disease, please keep the water within a certain range according to the parameters of "Water quality and maintenance". If you have listed similar situations, please stop using the spa and take medicines immediately.
- When using the spa, please don't remove the basket and the filter in filter cabin.
- Prohibit the use of calibrated flow rate was lower than the suction device to replace the original suction device, if the suction device is damaged or missing, do not use a spa bath. It is forbidden to replace the original suction device with the suction device with a flow rate lower than the rated flow rate. If the water suction device is or damaged missing, please don't use the spa.

Safety guidelines

- **Loose dothing and hanging jewelry must be away from the selected nozzle, backwater device, filtration device or other moving parts.**

⚠ Necessary:

- Before using, please ensure that the spa was installed by qualified professionals and the installation complies with the local electrical safety regulations and the requirements on the water and electrical installation.
- The electrical circuit in according to the electrical safety regulations and ensure to connect the power correctly - select a qualified electrical contractor
- Please ensure that the spa is installed in a place with good ventilation and drainage. The drainage device must be away from electrical cabinet and all electrical components.
- Please take care for the safety of children and lock the children safety cover after each use, in order to prevent that the children open it and accidents occur.
- Please check the leakage protection breaker each time before and after using the spa and wait at least 30 seconds .
- Before restarting it Ensure that the temperature of hot water supplied to the spa is less than 40°C (104 °F).
- Please don't turn on the external circuit when draining water and electrical repairing. Please check the ground fault circuit breaker before each use.
- Before entering the spa tub, the user should measure the water temperature with an accurate thermometer, because the deviation of the temperature adjusting device will reach $\pm 2^{\circ}\text{C}$ ($\pm 5^{\circ}\text{F}$).
- Before allowing children to enter into the spa, please test the water temperature firstly with hand, in order to ensure suitable water temperature, because children are very sensitive to hot water.
- When the spa is in trouble, it must not be disassembled and repaired privately or by non-professionals. In this case, please notice the dealer or contact the products service center immediately.

Important guideline for using spa

We strongly recommend you to read the following guidelines and follow all instructions

⚠ Precautions:

- Follow the precautions and maintenance methods of the spa recommended by this manual.
- Use of accessories according the specifications and recommended spa-chemicals and cleaning agents (for details, see "Quality and Maintenance").
- When not using the spa, regardless of whether there is water in the spa, the cover should be put on and locked.
- In the case that there is no water in the spa or the cover is not closed, the spa is not allowed to be exposed to sunlight, because this may damage the housing material and speed up aging of the accessories.
- Don't roll or slide on the side of a spa. It can damage the sidewall.
- In the case that the cover is locked, please don't open or pull the cover directly. You should use the handle to lift or carry the cover, in order to avoid damaging the spa-surface.
- Please don't try to open the electrical control box and to repair the parts in the box privately ,Otherwise, the after sale warranty will become invalid. If there are problems by the operation, please carefully follow the operation Procedure described in "Troubleshooting" of the electrical control box, that is attached to the spa. If you still can not resolve the problem, you can contact the authorized dealer of our company and the authorized service personnel can help you to solve problems easily through telephone.

Please remember these guidelines.

Installation

Preparation of installation site

You have perhaps selected a place for the new spa, either indoors or outdoors, in courtyard or on platform. The following points should be checked.

- The spa should be installed on a solid, flat, horizontal surface with good water drainage and air ventilation. The surroundings must keep dry in order to ensure the safety of the electrical components.
- Place can withstand this weight. The installation site can not be selected on the soft surface, such as sand, lawn and soft soil, etc.
- Before filling water, please remember to carry out leveling for your spa (see "Preparation of leveling").
- Please ensure that the equipment cabin containing all electrical components is away from the drainage system. If water enters into the equipment cabin, it will cause damage to electrical components or turn-off of the circuit breaker on the power distribution board.
- Please install the equipment cabin in a convenient location, in order to carry out the regular maintenance to the spa.

⚠ Warning: damages of the components or pipelines in the equipment cabin caused by mouse will not be covered under the warranty.

Installation in outdoor and courtyard

- Wherever the new spa is installed, a solid foundation to support the weight of the spa is important. Incorrect installation and structural damage caused by improper installation is not included in the spa warranty.
- If you install the spa outdoors, we recommend a reinforced concrete foundation with a thickness of at least 10 cm. According to the national electrical requirements, the reinforcing bar or steel net in the concrete foundation should be grounded.

Platform/indoor/basement installation

- If you install the spa on a platform, please consult a qualified building contractor or structural engineer to know the maximum load bearing capacity of the platform, in order to ensure that the platform can withstand the weight of the spa.
- If you install the spa indoors, you have to understand certain special requirements. There will be water around of the spa, so the flooring materials must have good slip resistance. Water could splutter from the massage pool onto the floor around the massage pool. A correct drainage is necessary to prevent the water around the spa.
- If the spa is installed in the basement, the air humidity will naturally increase during usage and the moisture will enter the electrical equipment cabin, and cause safety risks. In order to minimize these influences, sufficient ventilation for the basement is necessary. An architect can help you determine whether you need to install an additional ventilation device. But a correct drainage is also necessary.

⚠ Warning:

- When the spa is installed indoors or in small spaces, please keep good ventilation surrounding the spa.
- Poor ventilation can lead to the accumulation of chemical substances or bacteria in the spa higher than normal levels. These anti-scatter chemicals or bacteria could be inhaled and cause breathing difficulties and lung damage of the patients with immune system or respiratory infection diseases. If you and others have these diseases, please see your doctor as soon as possible. In addition to the above description, it should also properly clean and maintain your spa bath as follows.
- We recommend installing the spa on the ground. But if the ground is on the same level to the upper edge of the spa, or higher than the spa upper edge because of laying floors, the risk of accidentally falling into the spa will be greatly increased. Therefore, please contact a qualified builder to design or evaluate your installation platform.

In addition to the above description, your spa should also be properly cleaned and maintained as follows:

- Test water quality regularly to ensure the retaining level of disinfectant, acid and alkali lowering agents and other water treatment agents.
- Drain, clean and add water regularly in accordance with this manual.
- Clean the filter at least once a monthly.
- Check and ensure normal cycling of the spa water system. Users should wash their body before entering into the spa.

Installation

Preparation for spa leveling

- The inclination of the concrete ground is preferably 1.3cm/3m, so rainwater and overflowed water spilled will flow out, and not remain under the spa (water remaining long time under the spa could lead to putridity of wood floor).

When selecting stepping stones or railway sleepers as the foundation for the spa, these should be placed below the entire spa and leveled, in order to keep the weight of the spa evenly distributed.

- Please note, the soft ground will have a tendency to sedimentation, so that the spa is no longer in the leveling state, even if the weight of the spa has been evenly distributed as much as possible by using the stepping stones.

⚠ Warning:

If the spa is installed on the grass or muddy ground, the number of floating debris in water will increase and damage the equipment the surface of the spa. This situation is not covered by the warranty.

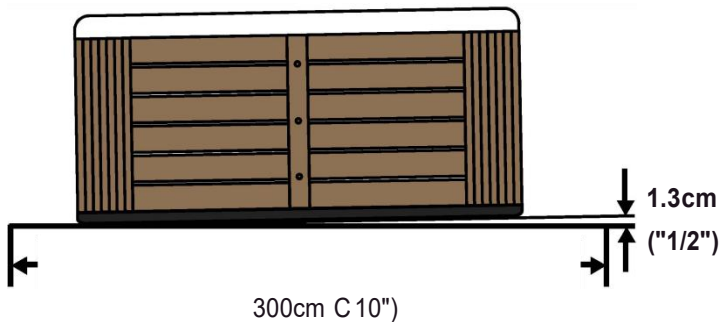

For CORrect water drainage, the indination should be 1.3 cm (1/2 inch) / 305 cm (10 inches)

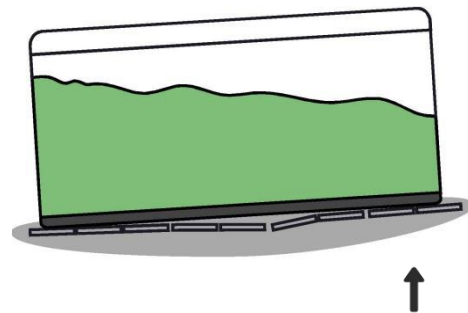

The spa could loss its leveling state becau of the sinking of the stones or bricks se

⚠ Tips:

Spa is specially engineeed and can be installed on different kinds of common courtyard ground. The most suitable foundation is the concrete plates. But other foundations can also be used. You have only to prepare a foundation in the leveling state before delivery. When a spa is installed in a place without gazebo or other attachments, the coneete plate can be replaced by foundation examples shown in two foundation drawings on right side.

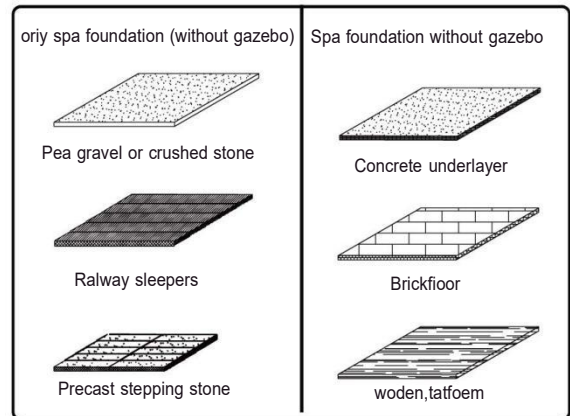

Cover installation

- Install the cover correctly on the spa.
- Fix lock catch of the cover on the spa side,so that the cover band can be easily fastened on that The cover band may loose 1.5-2cm, so that it can be easily inserted into the lock catch.
- Fix the lock catch with the provided SCrews and insert the cover band into the lock catch.

Note: When the spa is not used, closing the cover can reduce the operating time of the heater and minimize the cost of usage.

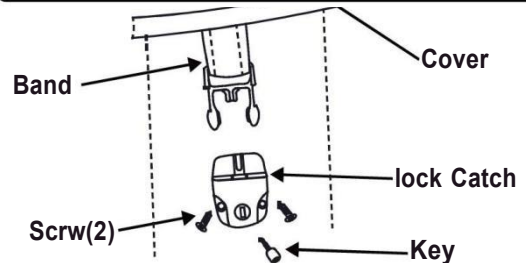

Danger:injury

- Do not let the Spa in uncover or unattended state
- Do not forget to lock the Spa cover
- Do not stand, sit or lie on the cove

Electrical installation

Electrical requirements and precautionary measures

We provide maximum security for you to prevent electric shock. But, if the electrical circuit of the spa is connected incorrectly, many security functions of the spa shall be influenced. Please read carefully and follow completely the electrical installation requirements and instructions for the specific spa type.

- Laying the interface electrical line, setting the interface switches and junction box must comply with IEC international safety standards IEC or national safety standards.
- The cross sectional area of the electrical power line for the interfaces must be able to meet the power requirements of a corresponding spa type. It should be a copper cable with 500V rated voltage
- Rated current of power switch/junction box must be able to meet the power requirements of a corresponding spa type. It must be set up independently and is not used together with other electrical appliances.
- The power switch must be installed in a non-readily accessible place in accordance with safety rules.
- Power switch/junction box must be grounded to prevent electric shock. At the same time, a waterproof leakage switch must be connected with the power line of the spa.

All electrical installation work should be completed by professionals recognized by relevant departments.

Cable duct installation instructions

- When connecting the circuit, first remove the screws from the equipment cabin door and carefully pull down the door panel, and then removed it from the spa completely.
- Fix the control box position, release the screws on the control box outside, then remove the screws and the control box cover.
- Insert the cable pipe into the reserved electrical hole on the spa skirt and connect the cable with the control box according to the detailed description on the wiring diagram in the control box

⚠ Warning:

- Removal or bypass of the breaker will lead to loss of safety protection for the Spa and to the warranty invalid.
- If the line is longer, please use more coarse wire than the predetermined.

Wiring regulations

Leakage switch pre-installed by user

Leakage switch pre-installed on the

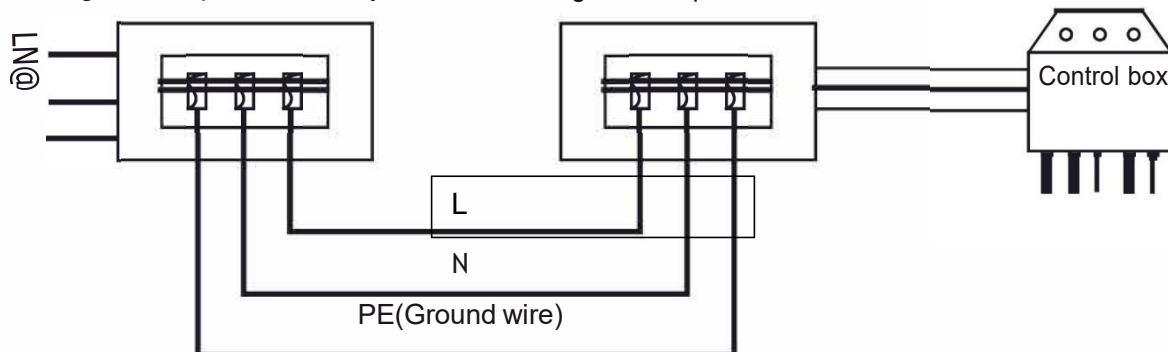

- A leakage protection switch with a current not less than 40A and a leakage current not more than 30MA should be installed in current front-end.
- An all-pole disconnect device with a contact open position more than 3mm should be installed in the fixed wiring.

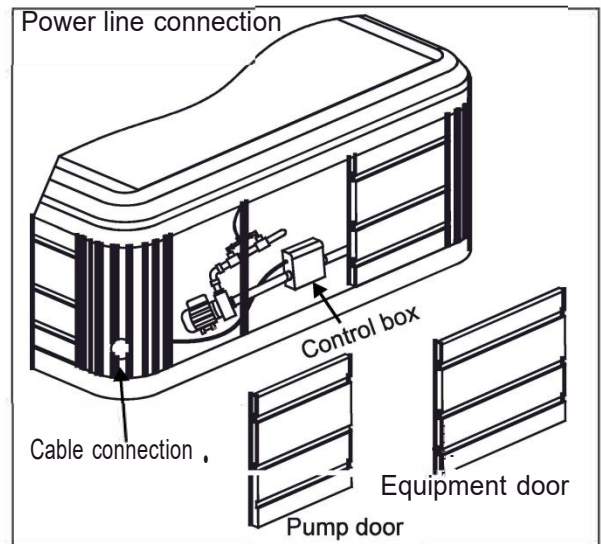

Electrical installation

Power line connection figure

- 380V three-phase/five-wire: Live wire (L1) Live wire (L2) Live wire (L3) Null wire (N) Ground wire (G)

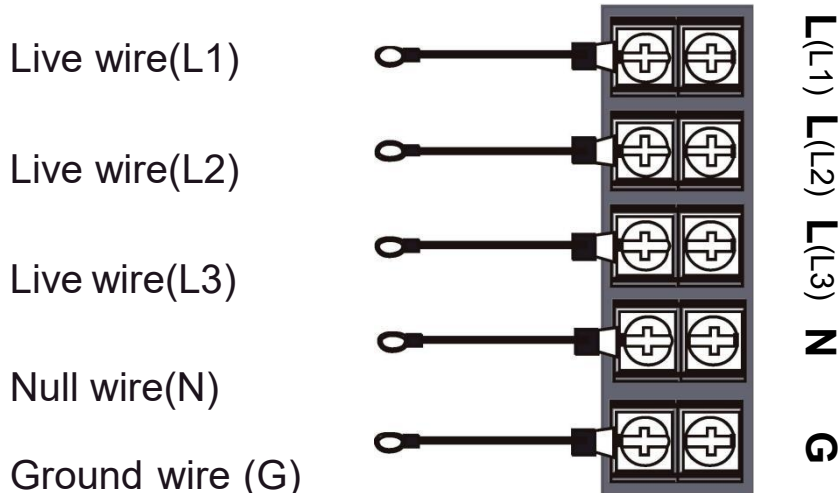

- 220V single-Phase/three-wire: Live wire (L), Null wire (N), Ground wire (G)

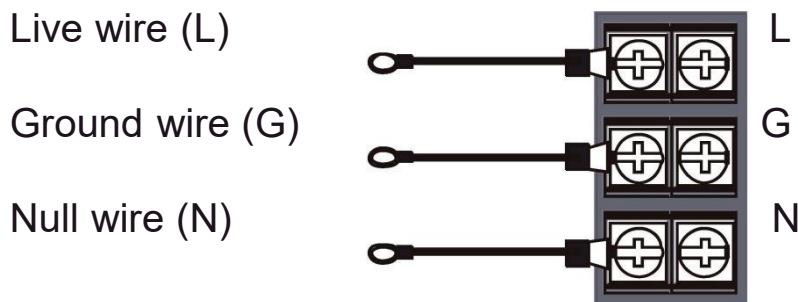

- 110V two-Phase/four-wire: Live wire (L1), Live wire (L2), Null wire (N), Ground wire (G)

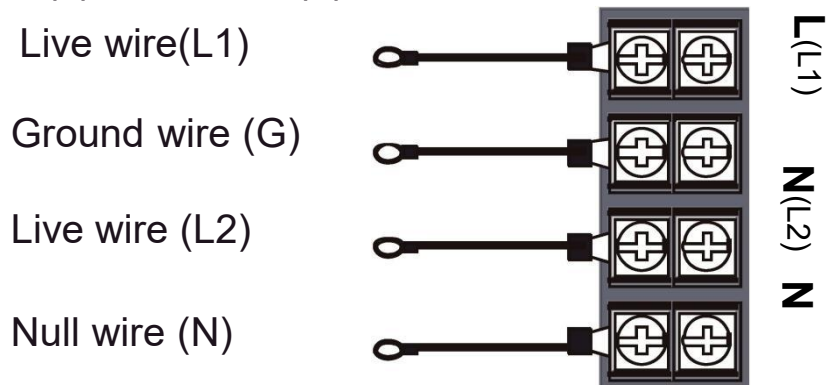

Note: connect the power line according to the above mentioned figure

Nozzle menu

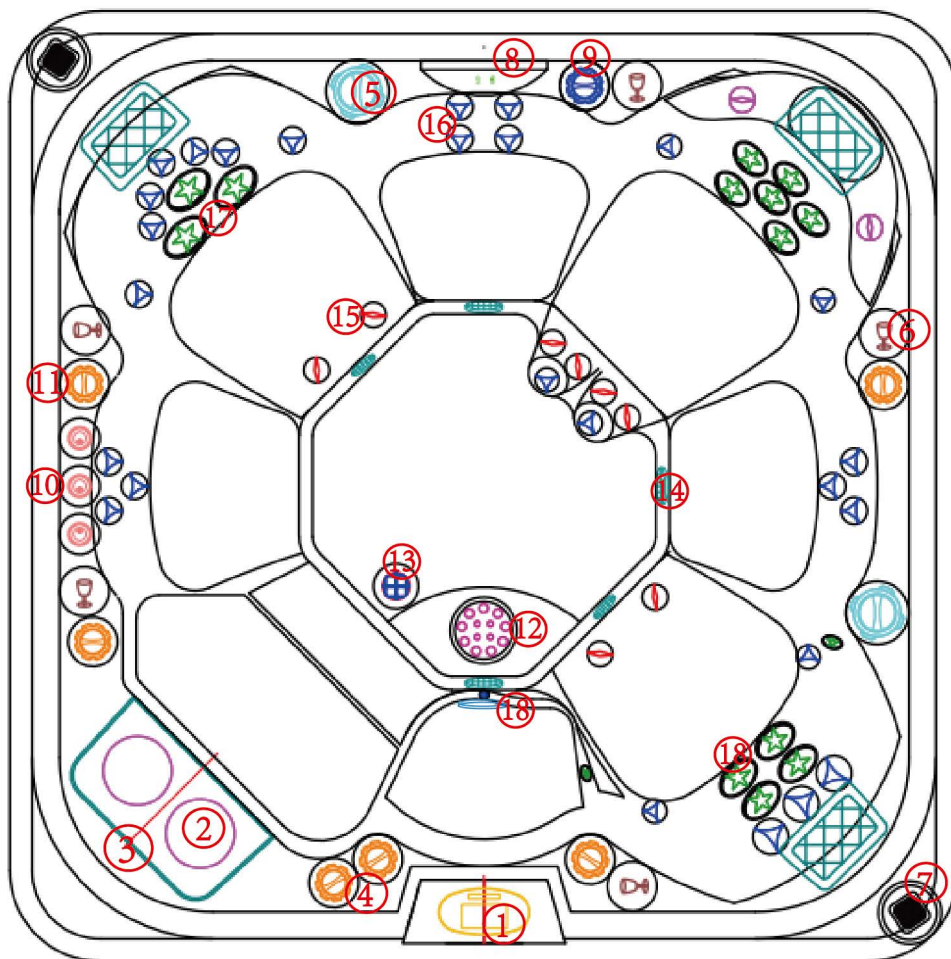

SR8174

Topview

- | | |
|------------------------|----------------------|
| ① Control panel | ⑪ Fountains valve |
| ② Filter | ⑫ 7" straight nozzle |
| ③ Filter paper core | ⑬ Drainer |
| ④ Air regulating valve | ⑭ Suction |
| ⑤ Splitter valve | ⑮ 2"straight nozzle |
| ⑥ Cup holder | ⑯ 3.5"nozzle |
| ⑦ Speaker | ⑰ 5"nozzle |
| ⑧ Waterfall | ⑱ Bottom light |
| ⑨ Waterfall valve | |
| ⑩ Fountains | |

Start and adding water procedure

To ensure the reliability of the product and long-term satisfaction of customers, Spa is detailed tested during the manufacturing process. After detecting, a small amount of residual water could be left in the pipeline and pollute the tub or skirt surfaces before delivery. Please clean the spas with a soft doth before filling water. In order to ensure a successful start and filling water, please carefully read and strictly follow the instructions below.

Warning

- a) Do not fill hot water into your spa to avoid tripping of the overheating protection switch.
- b) Do not switch on the spa without water in it. After the spa has been switched on, internal key components (such as controllers, heaters and other systems) will start automatically.
- c) These components could be damaged when electrifying without water in the spa. The damage could be not covered under the warranty.
- d) Please don't use the spa before completing all of the following steps, even if the spa has been filled with water.
- e) Do not add chlorine when the spa is disinfected by using polyhexamethylene biguanide (biguanide, PHMB) disinfectants.
- f) Before filling water into the spa for the first time, please remove the door of the equipment cabin, check and ensure that the jet pump was closely connected with the joint on one side of the heater.

● Close all drain pipes, remove the filter cabin cover, the filter basket, the floating weir and filter and then fill water into the spa through the filter cabin by using a hose connected to the water pipe with a filter. Keep the water level one inch above the highest nozzle. Reinstall the filter, the filter basket and floating weir after filling water.

Important note: Recommends not filling "soft" water into the spa, in order to avoid damaging the equipment

● After filling water and dosing the equipment cabin door, the spa must be powered.

a) Turn on first the power supply of the spa control system from the indoor main distribution box.

b) Next, open the panel door and reset the GFCI breaker.

c) Finally, close and lock the secondary panel door.

● Check the injection system operation status and discharge residual air from the heating system, then press the control button "nozzle" on the control panel and let the injection pump run with high-speed. Once all nozzle system (strong, non-paroxysmal injection) is started and has a strong non-paroxysmal injection, it means that the injection system can fully normal work, so the start of filling water has been completed. Close spa function. If you feel unstable water flow from nozzles, please refer to the instruction for jet pump start in the section "spa problem solution" in this manual.

● Adjust the total alkalinity (TA) to 40-120ppm and the calcium hardness (CH) to 50-150ppm by using test paper and appropriate chemicals, and then adjust the water pH to 7.2 - 7.6. These steps are described in the section "Water quality and maintenance". Instructions: the first step should be to adjust the total alkalinity. This is very important, because the pH value will not be correctly adjusted and the effective functioning of the disinfectant will be impeded, when the total alkalinity does not reach equilibrium. Important note: please start the cleaning cycle function before adding the chemicals directly into the filtration cabin. Make sure that all bypass valves are adjusted to the middle position. Clean function operation, please see the instructions attached to the panel.

● Per 950 liters (250 gallons) of water should be added with 1½ teaspoons of chlorine (sodium bichloride) to conduct the water chlorination treatment.

● Temperature control: the preset temperature of the spa should be 39°C (100° F). It normally takes 18—24 hours to reach this temperature. Put the vinyl-cover on the spa to keep the water temperature stable. Ensure that the cover has been locked. Regularly check the water temperature in the spa. The next operation can begin, when the water temperature is higher than 32°C,

● Test residual bromine in water by using test paper. If the residual bromine is between 1 and 2ppm, the next operation can begin. If the residual bromine is less than 1 ppm, please start the cleaning cycle and test again. Important note: if the disinfectant concentration is too high, it may lead to discomfort of the eye, lung and skin of user. Before using the spa, please remember to lower the disinfectant concentration to the recommended range.

● Recheck whether the total alkalinity (TA) is 40-120ppm, the calcium hardness (CH) is 50-150ppm, the water pH value is between 7.2 and 7.6. Instructions: please adjust absolutely the total alkalinity firstly, because the pH value will not be correctly adjusted and the effective functioning of the disinfectant will be impeded, when the total alkalinity does not reach equilibrium.

● When the water has been circulated and the chlorine concentration is maintained between 1—2ppm, the spa is ready for use. The spa offers you various massage ways. You can find a suitable way through the trial massage: try to sit in different seats, adjust diverter valves and nozzles, and open and dose every jet pump

Start and adding water procedure

Spa offers you various massage modes. Please try to find your suitable mode: adjust the diverter valves, the airregulating valves and nozzles, and open or dose one of the jet pumps.

Diverter valves

Diverter valves allow you to guide the water from the jet pump to different nozzle combinations. By the following test, you can fully understand the function of these diverter valves.

- Set all of the air regulating valves in the open position.
- Open the two jet pumps.

Turn the switch of every diverter valve and view which nozzle combination is controlled.

(You can adjust the diverter valve to any position between two possible ends to get the best nozzle pressure you need).

Important: when the diverter valve is in the "middle" position, from the design perspective of the spa, the nozzles can not provide the maximum pressure. However, when the diverter valve is in this position, you can turn the switch to close the unused nozzle, in order to increase the pressure of the selected nozzle. Tip: Open two jet pumps and set the diverter valve in the "middle" position. Then test every air regulating valves and feel their effects.

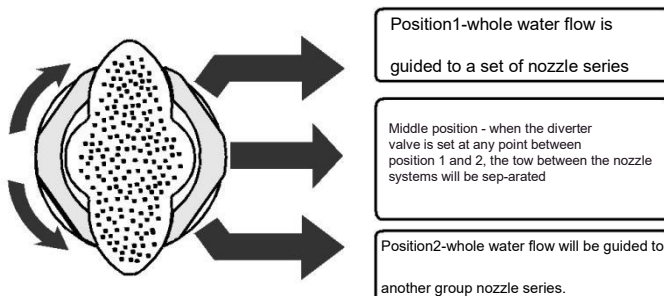

Waterfall valve

- All spa is equipped with a waterfall device. To start this device, please turn the control valve once or more times until the waterfall appears.
- The waterfall function can form injected water to different shapes.
- By opening the control valve on the spa surface, you can adjust the water flow in low high speed.

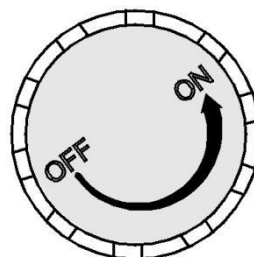

Perfume box valve

- Perfume box function allows you to enjoy the enthusiasm and fantasy from the perfume.
- You can adjust the fragrance concentration and create a warm and romantic environment.
- According to personal preferences, you can change the perfume in the box. By opening the control valve on the spa surface, you can adjust the fragrance concentration, light or thick.

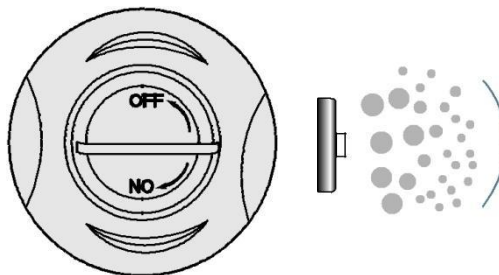

Air regulating valve

- Air control function allows you to enjoy massage with different pressures from the nozzles.
- Each nozzle system has its own control device. By opening the control valve on the spa surface, you can control the nozzle pressure through adjusting the air amount in the water flow.



SR8174

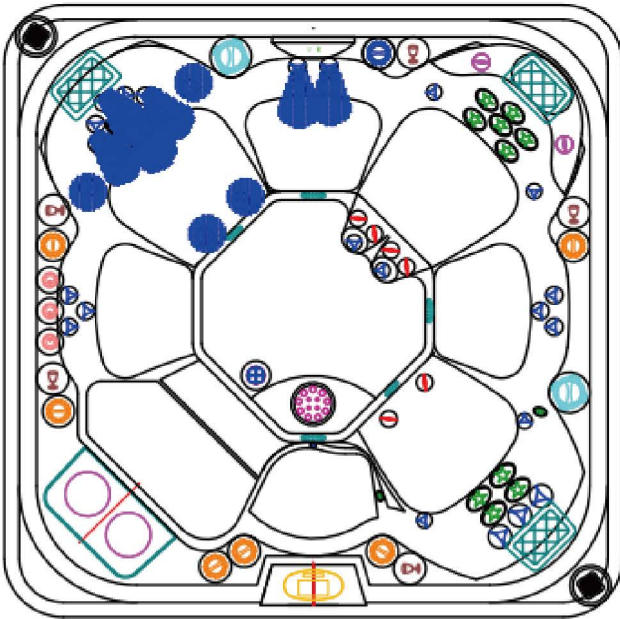

Jet pump1-nozzle system 1
Located in the uper left
16 spa nozzles

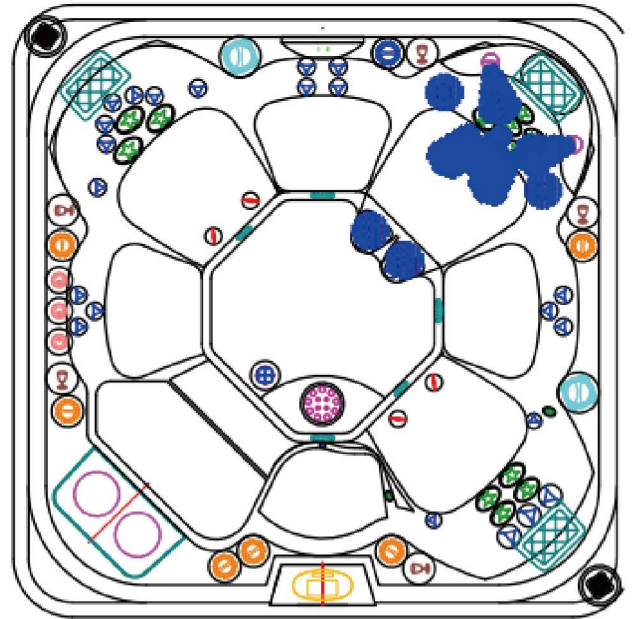

Jet pump1-nozzle system 2
Located in the uper left
16 spa nozzles

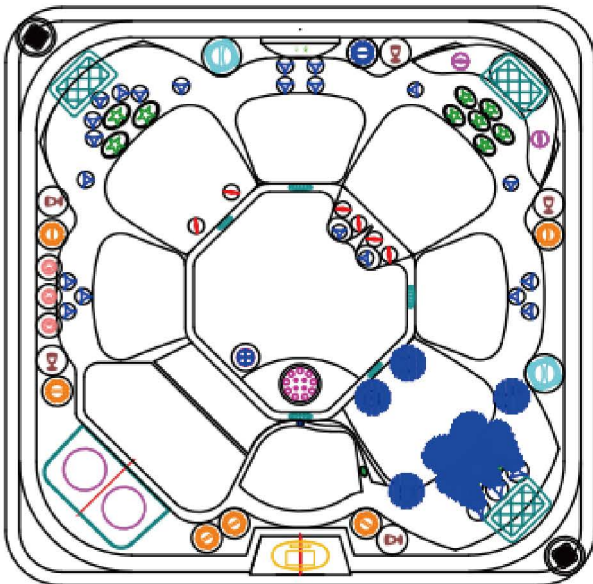

Jet pump 2-nozzle system 1
Right center 11 seat nozzle

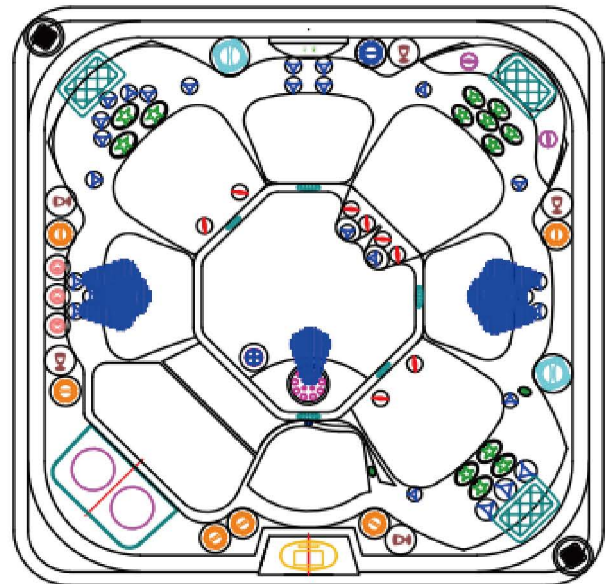

Jet pump 2-nozzle system 1
Right center6 seat nozzle
1 bottom nozzle

Equipment cabin

Side view of jet pump

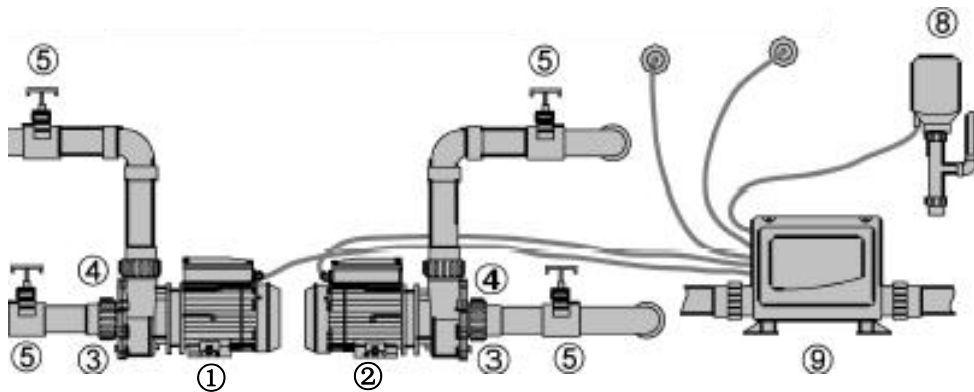

- | | | |
|---------------|-----------------------|------------------------|
| 1. Jet pump 1 | 5. Pull valve | 8. Water level sensor |
| 4. Pipe joint | 6. Temperature sensor | 9. Air pump |
| 2. Jet pump 2 | 7. Pipe joint | 10. System control box |
| 3. Water pump | | |

Side view of control device

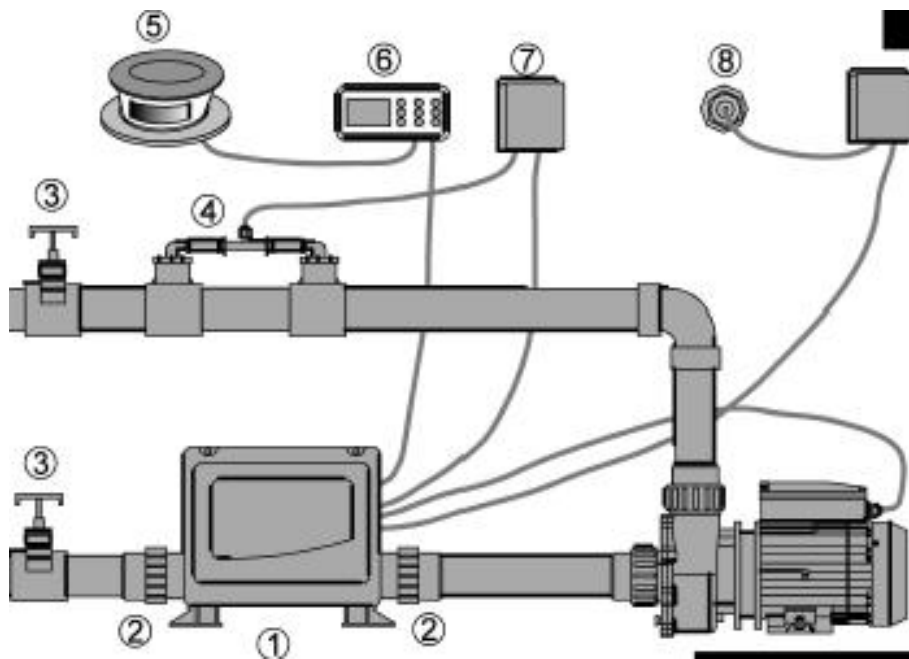

- | | | |
|-----------------------|-------------------------|---------------------|
| 1. System control box | 4. Zone nozzle | 7. Zone generator |
| 2. Pipe joint | 5. Speaker | 8. Light |
| 3. Pull valve | 6. System control panel | 9. Light controller |
| | 10. Circulating | |

Maintenance

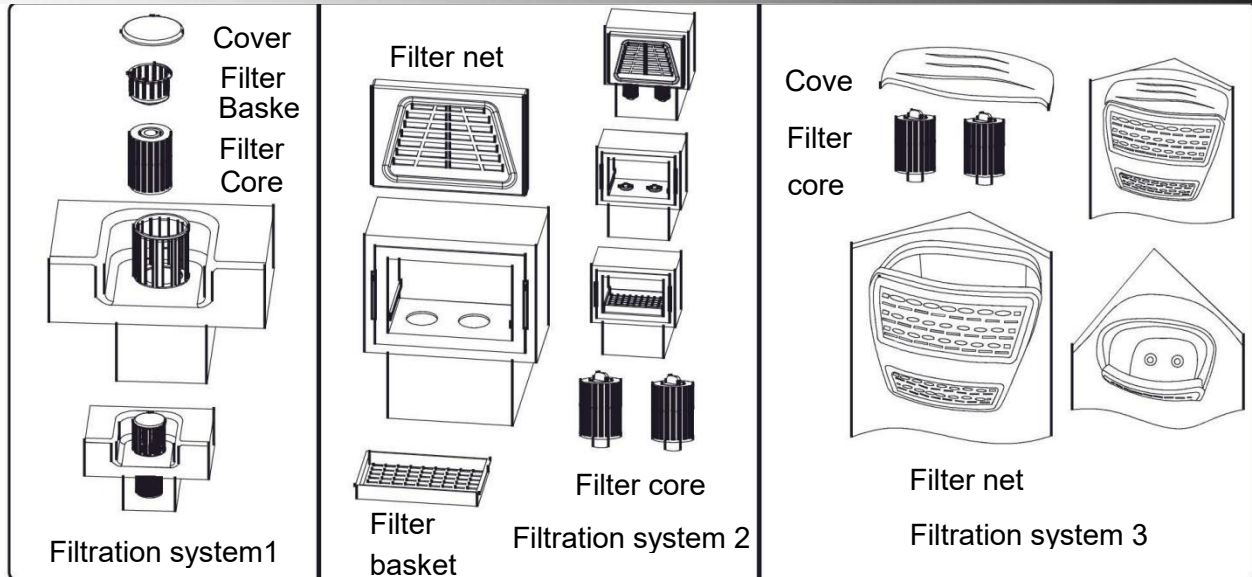

Disassembly and installation of filtration systems 1

- A filtration barrel with water supply pipe is installed under the filtration core and each water hole of the filter core is connected with the pipe joint on the filter basket tail. When disassembling the filter core, please first screw out the cover counter clockwise, then catch the handle in the filter basket and put it in a suitable place for cleaning or replacing the filter core.
- When installing the filter core, please first put the filter core in the preset place of the filtration barrel. At the same time, press the filter core down in its place and then connect the pipe joint on the filter basket tail with each water hole of the filter core. After that, press the filter basket down in its place. At last, screw the cover clockwise. Before please check whether the filter system is perfectly installed.

Disassembly and installation of filtration systems 2

- A filtration barrel with water supply pipe is installed under the filtration core. When disassembling the filter core, please first pull up the filter net, take out the filter basket and then the filter core for cleaning or replacing the filter core.
- When installing the filter core, please catch the handle on the filter core and connect each water hole of the filter core with preset pipe joint of the filtration cabin. At the same time, press the filter core down and then push the filter basket into its place. At last, install the filter net. Before starting the jet pump, please check whether the filter system is perfectly installed.

Disassembly and installation of filtration systems 3

- A filtration barrel with water supply pipe is installed under the filtration core. When disassembling the filter core, please first pull up the cover and then take out the filter core for cleaning or replacing it.
- When installing the filter core, please catch the handle on the filter core and connect each water hole of the filter core with preset pipe joint of the filtration cabin. At the same time, press the filter core down in its place. At last, install the cover. Before starting the jet pump, please check whether the filter system is perfectly installed.

Filter maintenance

- Check and clean the filter basket at least once a week in order to ensure the normal operation of the filter system. Clear away leaves, foreign matter and residues. Remember to keep the filter core clean and free of particles to ensure proper water flow. A clean filter core can ensure the normal operation of spa systems and realize more efficient filtration cycle.
- We recommend cleaning the filter once every four weeks. However, the exact number of cleaning depends on the use frequency. Otherwise, the filter may be clogged and limit the water flow, thereby lead to abnormal filtration, lowering nozzle performance, and even freezing.

Important: use frequency and duration as well as number of users, all of this will affect the cleaning interval. The more the spa is used, the more cleaning is necessary.

Filter core cleaning instructions

Disconnect the power of the spa and then proceed the following operations:

- Carefully pull out the filter core according to the disassembly steps of the filtration system.
- Please remember to clean the filter only with filter special degreasing agent, in order to clear away minerals and grease from the filter. You only need to soak the filter in the degreasing agent according to the instructions on the degreasing agent package and then place it onto a clean surface, and wash it with water. During washing, you may need to rotate the filter in order to wash away the dirt between the folds of the filter.

Maintenance

- Install the filter system according to the above mentioned installation procedure and lock it perfectly, and then shut on the power of the spa.

Note: For purchasing spare part, please contact your dealer. Please refer to the filter system model of your spa and ensure the correct size of the filter

Diverter valve maintenance

If the diverter valve of your spa is difficult to rotate, the reason could be the accumulation of residues in the valve. Please remove such residues as soon as possible to prevent damage to the diverter valve. In order to do this, please follow these steps:

- Switch off the breaker on the panel to shut off the power supply to the spa.
- Lift and shake back and forth to remove the diverter valve handle.
- Pull up and remove the valve body
- Wipe the valve body and the valve inner wall.
- Lubricate the o-ring with waterproof lubricants delivered by your dealer.
- Reinstall the diverter valve and turn on the power to the spa.

Nozzle maintenance

If you find that the nozzle rotation speed is slower than a new spa, or the nozzle is sticky, the reason could be the accumulation of sediment in the nozzle bearings. To remove the sediment, please follow these instructions:

- Close the spa, rotate the nozzle panel, until the rotation of the panel stops.
- When the panel stops to rotate, please continue to rotate it counterclockwise with a larger force and let the panel pass the locking position, until the panel stops again. Pull out the panel and let the entire nozzle leave the spa.
- After washing the bearing in the nozzle with water, turn the rotary eye. Now, the nozzle should be able to rotate freely. If it can still not freely rotate, you can soak the bearing in a cup of vinegar for one night (cider vinegar can soften any sediment). Wash the bearing with water on next day and then carry out a rotation test

Note: If the bearing can still not freely rotate, you need to soak it one night more. If the bearing still does not rotate, you must purchase a new one by the dealer

- To replace the bearing, please put the bearing opening down to the panel rear end and push the panel into the spa. Gently rotate the panel in either direction, until you feel that the panel is aligned with the device. Then press the panel into its place, then rotate the panel with a little larger force clockwise and let it pass the lock position. If the panel does not rotate, please remove the entire panel, rotate it in 180°, and repeat this step. After opening the jet pump, the nozzle should be free to rotate.

Speaker operation

Operation pop-speaker: lift the speaker by pressing the speaker center.

- Pop-up speaker has only one lower position.
- The mechanism could be damaged, if you hardly press it down into a different position.

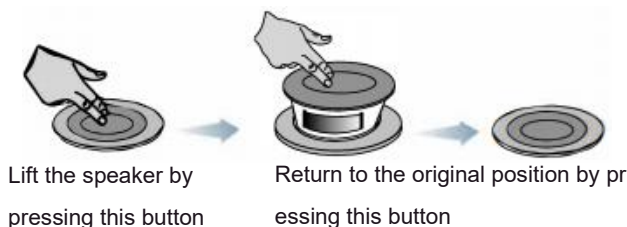

Perfume replacement operations

Depending on your preference for perfume, please follow these steps (two designs):

- Find perfume box and prepare perfume.
- Unscrew the box cover counterclockwise and take out the perfume box to replace the perfume.
- After replacing the perfume, please install the box in the correct order.

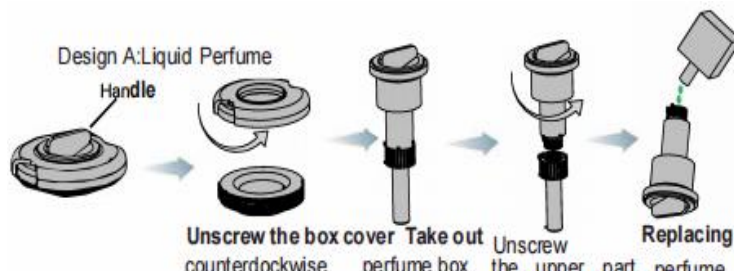

Note: the force for removal and installation should be appropriate, in order to avoid damage to accessories.

Design B: Solid Perfume

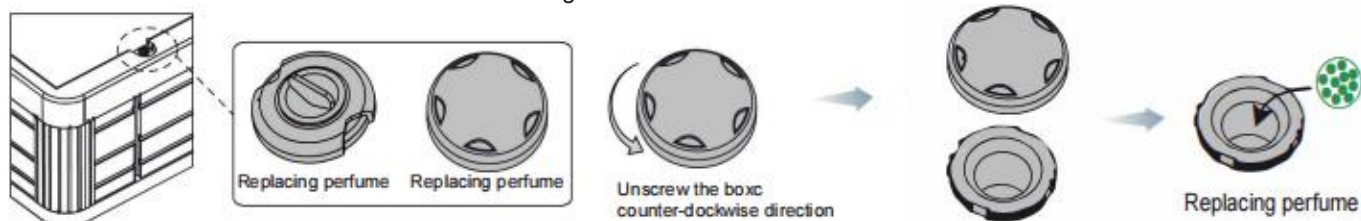

Maintenance

Water draining

- Find the main drainage. According to the procedure shown in the figure (two designs), remove the drain cap, connect the external drain hose to the drain end (to avoid flooding the foundation around the spa) and push the hose inwards to the drainage pipe and then pull the hose to a proper drainage area. Note: please don't bend the drain hose to avoid influencing drainage. Note: the water containing higher concentration disinfectant is harmful to programs and lawns
- Important note: the water can drain almost completely by through the drain valve all spa type. The water in jet pump, heating system and other equipment will also be discharged. The residual water in the pipe or equipment needs only to be discharged, when conducting the winter preparation.
- After draining water, please clean the tub and filter core
- Pull out and remove the drain hose, place the drain cap and push the drain pipe into the spa again as shown in the figures A
- Fill water according to "procedure of start and water filling".

Design A:

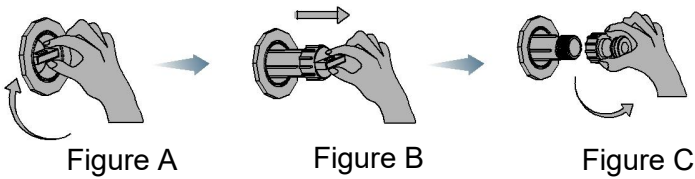

Figure A

Figure B

Figure C

Step 1

The drainage clockwise while rotating pull it, pull the end position (Figure B) Then remove the drain cap and connect drains.

Design B:

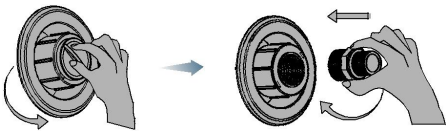

Step 1 Figures A

Figures B

Twist off the drain cover in counterclockwise (Figure A), and screw on the external drain connector in clockwise (Figure B).

Winter preparation

Your spa is specifically designed and suitable to any climatic conditions. Therefore, you can use it throughout the year. In some areas, extremely cold (below -12°C or 10 °F) with the strong wind is "hand in glove", even the water in the spa is kept at a selected temperature, the jet pump could partial freeze. In cold weather, the heater starts more frequently, that will result in reduced energy efficiency of the spa. In order to prevent partial freezing of certain components, the equipment cabin can be insulated with an insulation device (available from your local dealer). This insulation device can also help maximize energy efficiency of the spa.

Note: when the weather is warmer (temperatures of about 16°-21 °C or 60-70°F), the insulation device must be removed to prevent overheating of the jet pump.

Winter preparation measures

When the spa is not used in the cold winter for a long time, the water should be fully drained for winter preparation, in order to avoid unexpected freezing caused by power outages or equipment failure. Please follow the instructions below.

- ▲ Danger: Please only use non-toxic glycol to prevent freezing (available from most RV or marine supplies store). Never use automotive antifreeze (ethylene glycol), because it is toxic!
- Drain water from the spa according to the section "Spa drain" in this User' manual"
- manual" Remove the filter core and then store it in a dry place.

Design A

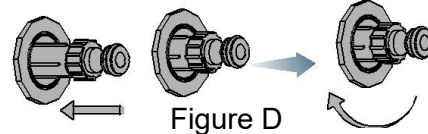
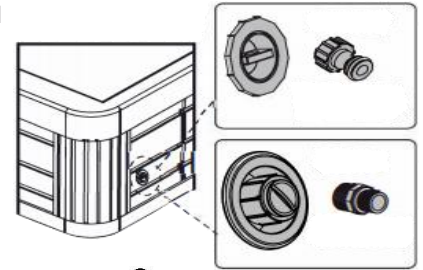
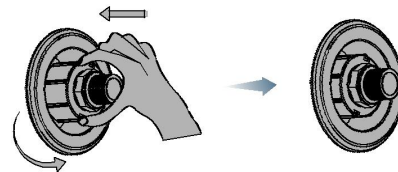

Figure D

Step 2

Push the drainage to the middle position (Figure D) And then rotated clockwise 30°, it can drain



Figures C

Figures D

Step 2

Press hard and rotated in counterclockwise until it can't pop up. (Figure D)

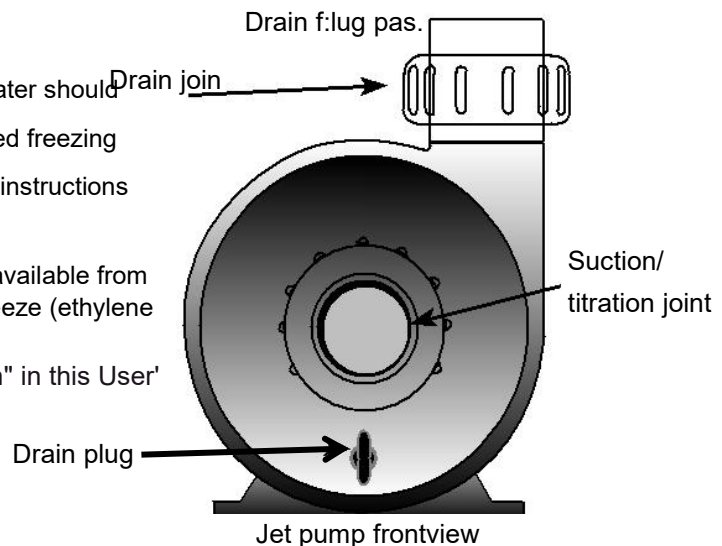

Jet pump frontview

Maintenance

- Important note: When the temperature drops below 0 °C (32° F), you have to drain water from the spa for winter preparation according to these additional steps and effectively remove the residual water from pipe lines by using a 19 liters (5 gallons) combined industrial vacuum deaner (vacuum cleaner/blower) with wet/dry function.
- If your spa has been equipped with an air blower, please pump the water from air nozzle pipes according to the steps below:
 - a) Shut on the 25A circuit breaker.
 - b) Start the blower by pressing button "AIR". Shut off the air blower after draining the water.
 - c) Shut off the 25A circuit breaker.
- Connect the deaner hose to the vacuum end of industrial deaner and dean all openings and holes with the deaner:
 - a) Nozzle opening: start from the top of the nozzle and then move downward (if the suction comes from another nozzle, please block it with a large rag, which helps extract out the water from deeper main pipes).
 - b) Suction/filtration accessories and filtration cabin.
 - c) Main drain opening: when extracting water from the main drain opening using a vacuum deaner, you may need to cover the drainage trash rack tightly with a piece of rag, in order to ensure the fully water draining from the internal pipe system.
- Dry the spa tub completely with a dean towel and reinstall the main drain cover.
- Fill antifreeze into all standpipes, jet holes and waterscape device holes using an elongated funnel. Add enough antifreeze to ensure adequate protection – in many cases, you will see the antifreeze at openings or the antifreeze flowing from elsewhere.
- ▲ Be careful!: Please only use non-toxic glycol to prevent freezing. Never use automotive antifreeze (ethylene glycol), because it is toxic!
- Close and fasten the spa cover. Put tow piece of plywood plate onto the spa cover, in order to distribute the weight of snow evenly. Put a piece of a plastic flake or tarpaulin onto the In the spa cover or plywood plate.
- Unscrew the drain tube and then take out the pump door after removing the screws on the equipment door. After taking out the pump door, unscrew the drain plug and drain the water completely.
- The drain plug should be placed next to the water pump. Loosen the pump pipe joint to let the water drain out. Keep the pipe joint in relaxed state. Note: tighten the pipe joint before filling water into the spa.
- Before using the spa, please remove the plastic flake, plywood plate and the spa cover. First unscrew the drain tube and then SCrews on the door to remove the pump door. After opening the door, reinstall the drain plug and tighten the pump joint. Fill the water into the spa according to "start and water filling procedure"
- ▲ Warning: when the spa is not in use, the spa must be dosed with the cover. Damage due to sun exposure or freezing is not covered under the warranty.

Pillow maintenance

Careful maintenance of the pillow can provide you with long-lasting comfortable enjoyment. Please place the pillow above the water level. This can minimize the discoloration caused by chlorinated water and other agents in the water. To extend the life of pillows, you have to remove and dean the pillows, when the spa is out of use and deaned. Please wash the sebum with mild soap water. Wash the pillows thoroughly and dean all soap residues. When you program not to use the spa for a long time (such as holiday or winter preparation) or carry out on water chlorination, you should remove the pillows until the next time.

Removing and reinstalling a pillow:

- Carefully lift off one end of the pillow and then the other end, until the pillow releases from all pillow holders. Important note: please don't try to pull the pillow vertically out of the tub notch, because this could damage the pillow and this damage is not covered under the warranty.
- When reinstalling the pillow, please carefully bend the pillow slightly, so that one pillow holder slides into the groove on the back of the pillow.
- Keep the pillow in slight bending form and let other pillow holders slide into the groove on the back of the pillow.
- After all the pillow holders slide into their place, press the pillows into the tub notch.

Exterior coating maintenance

The tub of spa has a smooth surface like polished granite. Normally, the surface is not contaminated with dust and dirt. You can easily dean most of dust with a soft doth or nylon brush. For the spa tub, most household chemicals are harmful. Therefore, you should dean the tub surface only using non-abrasive, non-foam deaning agents. Cleaning agents remaining on the spa tub must be deaned carefully with clear water. We recommend polishing the surface with a polishing agent, after the surface has been dried.

Service exprogramation:

- In case of non-prevention, the iron and copper in the water could cause stains on the spa tub. If the concentration of minerals dissolved in the water is higher, please contact with the dealer to get a recommendation for a scale inhibitor.

Maintenance

- We don't recommend to use alcohol or non-prescribed household cleaners for cleaning the tub surface. Do not use any cleaning products containing abrasives or solvents, in order to avoid damage to the tub surface. Do not use corrosive chemicals! Damage to the tub surface caused by using corrosive chemicals is not included in the warranty range. Important note: some surface cleaners contain ingredients irritating to eyes and skin. Please keep all cleaning agents in a safe place that the children don't reach. Please be careful by using these.

Spa tub skirt

- When cleaning the spa skirt, you can only use a soft cloth or sponge dipped in neutral soapy water. Abrasive cleaners or applicator agents will damage the surface gloss. The tub skirt must be thoroughly cleaned with clear water.

Spa cover maintenance

- The cover is made of leather and plastic foam. Please don't press it hard to avoid deformation or damage of the cover.
- It is used only to maintain the water temperature and to prevent that dust and children fall into the spa resulting in accidents, when the spa is out of use.
- The cover must be cleaned once a half month. By special circumstances (such as wind and rain, after the dust storms, as well as other human or non-human stain), please clean it in time.
- Cleaning steps: first slowly open the cover and put it against a wall. Then clean foreign matter and soil from the cover with a half dry rag.

Warning: the spa cover is a manual operated safety cover. If it is correctly installed and used, it can meet or exceed all current provisions for spa safety cover of ASTM standard. Covers being not fixed or not properly fixed belong all to danger source. Before use, open the cover fully. Don't clean it with acidic or corrosive cleaning agents. Human damage or damage caused by improper use and maintenance is not covered under the warranty.

Spa water maintenance

- The water in the spa will be slowly evaporated with time. This would increase the mineral content of the water and the water will gradually become harder. This can produce scale on the inner wall of the thermostat and cause great damage to the Thermostat
- Usually, the water in the spa could become green or brown, if the water contains high iron or copper ingredient. This will stain the tub surface. Therefore, you should regularly replace the water or add the right amount of minerals inhibitor to the water.
- Keep the water clean, prevent dogging phenomenon caused by hair and debris and blocking massage nozzles caused by impurities, that influences the massage effect and even the automatic thermostat

Water quality and maintenance

General information

Three aspects for water quality maintenance:

- Filtration
- Chemical regulation/PH value control
- Disinfection

The users have the responsibility to maintain the water in health status and regularly add qualified disinfectant to the water (if needed, add it every day). Through chemical methods, you can control bacteria and viruses in the tap water or in the water after using the Spa. Without disinfection, bacteria and viruses will increase rapidly.

The users have also responsibility to adjust the water through chemical method and to control the water PH value. You must add chemicals to the water and make the water total alkalinity (TA) \calcium hardness and PH value maintain normal levels. The correct water regulation and control of the water PH value can minimize the scale accumulation and corrosion of the metal, so that the life of the Spa is extended and the disinfectant can play the best effect.

Water quality and maintenance

Water test method

Correct test and analysis of the water quality is an important measure for effectively maintaining water quality.

In accordance with the recommended program, you must check:

- Total alkalinity (TA)
- Calcium Hardness (CH)
- pH value
- Disinfectants

Recognizes and recommends the following two test methods:

- Test with reagent is a method of higher accuracy. The agent can be in liquid or tablet form.
- The test with test paper is a simple method and many spa users use this method. Please remember that the test paper is sensitive to heat and moisture, and a heated or dampened test paper can lead to inaccurate readings.

Important note: please read and strictly follow the operation instructions in the test paper box to ensure accurate test results.

Basic chemical safety

When using chemicals, please read and strictly follow the operation instructions. Correct use of the chemicals can protect you and your spa. But high content of chemicals is harmful. Please follow the following principles:

- Only reliable adults are allowed to treat the spa chemicals. Chemicals should be placed out of reach of children.
- Accurately take and use the prescribed dose to the spa, not too much.
- All containers are to be handled with care and to store in a cool, dry, well ventilated place.
- Chemical containers must be sealed with corresponding covers, when not in use.
- Don't breathe fumes or allow chemicals touching eyes, mouth and nose. Wash hands immediately after use.
- In case of accidentally touching or swallowing chemicals, you must be treated in accordance with emergency treatment recommendations given on the product label. At this time, you have to call a doctor or your local poison control center. For medical treatment, please carry chemical containers in order to determine the composition of the chemicals.
- Don't let the chemicals drop onto the surrounding ground or green plants.
- Don't remove the dropped chemicals with the vacuum cleaner.
- Don't smoke near chemicals. Some chemical fumes are highly flammable.
- Don't store chemicals in the equipment cabin.

How to add chemicals to the water

Important: all spa chemicals, including the sodium dichloro cyanurate exc disinfection powder, MPS (monopersulfate), powdered pH value - increasing agent and inhibitors, powdered total alkalinity—increasing agent, calcium hardness- increasing agent, descaling liquid and defoaming liquid, must be added directly into or before the filtration cabin during the operation of the jet pump, which must run at least 10 minutes.

To add a watertreatment agent:

- Fold the spa cover. Carefully remove the filtration cabin cover and set it aside (to use timely).
- Find the button "dean" on the control panel and start the jet pump.
- Carefully take a recommended dosage of chemical and slowly pour it into or before the filtration cabin. Don't let the chemical sputter onto hand, eye, tub or tub sidewall.
- Replace the filtration cover (if any). After 10 minutes, turn off the jet pump, dose and lock the cover. Drowning danger: monitoring is necessary, while the spa is open!

Warning: if the disinfectant concentration is too high, this could lead to discomfort of the eyes, lungs and skin of the users. Before using the spa, please remember to let the disinfectant concentration to the recommended range.

Important note about the "superchlorination/non-chlorine oxidation treatment": after the spa has been treated through superchlorination or non-chlorine oxidation, the spa cover should be open for 20 minutes to discharge the oxidizing gas. If the high concentration oxidizing gas produced by oxidation treatment (not daily disinfection) is not discharged, this could gradually lead to a discoloration of the cover back or degradation of the vinyl basic material. Such damage is considered as chemical misuse and will not be covered under the warranty.

Water quality and maintenance

Water quality maintenance program

In according to the water quality maintenance program, each step must be done after completing the previous step. If one step is ignored or does not meet the proposed standard, it could lead to a water chemistry imbalance. This will damage the spa tub and its components, and makes the user discomfort.

Total alkalinity (TA) adjustment

- Water total alkalinity (TA) is 125-150ppm
- Total alkalinity means a metrics of the total content of carbonates, heavy carbonates, hydrxides and other alkaline substances in the water and is called as "pH buffers", that is the metrics of the ability of water to prevent the pH value change.
- If the total alkalinity is too low, then the pH value will largely fluctuate from high to low. pH value fluctuations can lead to corrosion or scaling on the spa components. If the total alkalinity is too low, it can increase by adding sodium bicarbonate (pH value/ alkalinity increasing agent).
- If the total alkalinity is too high, the pH value tends to be higher and is difficult to reduce. It can be reduced by using sodium bisulfate (pH value/alkalinity inhibitors).
- Once the total alkalinity of water reaches balance, it will usually remain unchanged - although the reading will increase and decrease after adding the water with high or low alkalinity otherwise.
- You can carry out the next operation, after the total alkalinity has entered into the recommended range.

Calcium hardness(CH)adjustment

- Recommended water calcium hardness (CH) is 125-150ppm.
- Calcium Hardness is a metrics of the total content of calcium dissolved in the water. Calcium helps control the water causticity. Therefore, we don't recommend low calcium water (which is usually called as "soft water"). The low calcium water is strong corrosive to the equipment and can lead to scaling on the spa tub surface and equipment.
- If the calcium hardness is too high (which is usually called as "hard water"), it will lead to scaling on the spa tub surface and equipment. The calcium hardness can be reduced by dilution method the calcium hardness can usually falls to the correct range by mixing 75% of the hard water with 25% soft water. If the soft water is not available or not applicable,you should add detergents to the water (according to label instructions of the detergents).
- If the calcium hardness is too low, then add calcium hardness increasing agent.
- Once the calcium hardness reaches balance, it will usually remain unchanged - although the reading will increase and decrease after adding the water with high or low calcium content otherwise.
- You can carry out the next operation, after the calcium hardness has entered into the recommended range.

pH value adjustment

- The ideal water pH value is 7.2-7.6.
- The pH value is a metrics of acidity. When the pH value is more than 7.6, the water is alkaline, when lower than 7.2, the water is acidic. Maintaining the proper pH value is of great significance. So you can:

- optimize the effectiveness of disinfectants.
 - keep the water use comfort.
 - prevent aging equipment.
- If the pH value of the water is too low, it may result in the following consequences:

- the rapid consumption of disinfectant.
- users have allergies.
- corrosion of the spa equipment.

Important note: if the pH value is too low, you can add sodium bicarbonate to the water(PH value/alkalinity increasing agent).

- If the pH value is too high, it may result in the following consequences.

- Reducing the effectiveness of disinfectants.
- Scaling on the surface of the spa tub and equipment.
- The water becomes turbid.
- Blocking of the filter pores.

Important note: if the pH value is too high, you can add sodium bisulfate (pH value/ alkalinity inhibitors) to the water to reduce the pH value.

- Regularly (once a week) check of the pH value is of great significance. All of the use frequency, the situation of adding the fresh water and various chemicals as well as the kind of disinfectants will influence the pH value.

- You can carry out the next operation, after the pH value has entered into the recommended range.

Alkaline water (scaling zone)	8.2	Add PH inhibito ↑ S to ↓ reduce PH value
	7.8	
Comfort Zone	7.6	Ideal range
	7.4	
	7.2	
Alkaline water (Corrosion zone)	6.8	Add PH inhibito ↑ S to ↓ reduce PH value
	PH	

Water quality and maintenance

Keep the concentration of disinfectant

- In killing algae, bacteria and viruses and preventing the proliferation of harmful microbes in the spa bath proliferation, disinfectants play an extremely important role. But excessive use of disinfectants is not allowed, because this can irritate the skin, lungs and eyes.
 - The disinfectant concentration should always be maintained at recommended level.
 - Recommends only the use of dichloroisocyanuric acid sodium (sodium bichloride or sodium chloride) as disinfectant.
- ⚠ Warning: please don't use trichloroisocyanurate, bromo-chloro-dimethyl hydantoin (BCDMH), or any bromine or chlorine in solid form, acid or any kind of disinfectants that is not recommended.

Water quality maintenance quick reference					
Step		Ideal range (PPM)		Chemicals used	
		Minimum	Maximum	Increasing agent	Inhibitors
1	Total alkalinity	125	150	Sodium bicarbonate or baking soda	Sodium bisulfate
2	Calcium hardness	150	200	Calcium hardness increasing agent	Mix 75% hard water with 25% soft water, or use detergents
3	pH value	7.2	7.6	Sodium bicarbonate	Sodium bisulfate
4	Disinfectants	See the section "Keep disinfectant concentration"			

Water treatment system

Water treatment system consists of the following products:

- Minerals filter core
- Sodium bichloride
- chlorine-free oxidizer (monopersulfate)
- Corona discharge (CD) ozone generator

Minerals filter core is used for adding chemicals to the water, in order to inhibit the growth of bacteria. This can oxidize particles in water when using together with chlorine-free oxidant (monopersulfate).

Important note:

- When using various types of products, please remember following the recommended application and maintenance program. You need to increase the amount of disinfectant after the spa has been used for a long time (such as an entire afternoon or evening).

● "Oxidation treatment" is required once a week, that can quickly destroy residual dirt and restore the vitality of bromine in the water.

● "Oxidation treatment" is required once a week, and the frequency of the oxidation treatment has to increase, if the spa is used more frequently.

Replacement instructions for filter core

Minerals filter core should be replaced once four months. When replacing the minerals filter core, we strongly recommend to drain the water completely and then re-add the water. Then adjust the total alkalinity (TA), calcium hardness (CH) and pH value to the recommended level. Add chlorine-free oxidant for oxidation treatment.

Important note: by replacing the filter core, please refer to the instruction of previous "filtration system installation and disassembly".

Water quality and maintenance

Chloride (sodium bichloride)

- Chemical disinfectants such as chlorine, are oxidants used to kill bacteria and germs in water. The free residual chlorine (FAC) means the measurable chlorine amount remaining in the water, that can be used for disinfecting the spa.
- We recommend using chlorine particles of sodium bichloride for water disinfection, because sodium bichloride can be completely and rapidly dissolved in water and its PH value is close to neutral.
- During use, it is extremely important to maintain the proper level of chlorine.
- If the content of the free residual chlorine (FAC) is too low, bacteria and viruses in the warm water can grow rapidly. Please increase the free residual chlorine (FAC) by adding sodium bichloride articles.
- If the content of the free residual chlorine (FAC) is too high, the water in the spa can irritate the eyes, lungs and skin. The content of the free residual chlorine (FAC) is automatically reduced after waiting for some time.
- When free residual chlorine (FAC) keeps in the recommended range, you can safely use the spa.

⚠Warning: Many kinds of stabilized chlorine can be used for a spa or swimming pool and each kind has its specific chemical properties. It is extremely important to select a spa-special chlorine. Incorrect use of trichloro with a very low PH value (PH2.6, too fast dissolving in the water resulting in a very high chlorine content, specifically for concrete or pool) will damage your spa. Your spa could be damaged by using liquid or solid bromine, chlorine, acid or any kind of disinfectants other than SUN RANS specification. This damage will not be covered under the warranty.

Important: by improperty storing, the granular form chlorine (sodium bichloride) will be decomposed. We recommend the purchase and use the chlorine in 1 pound, 2 pounds or 5 pounds package. To maintain performance, please store it in a cool and dry location.

Chlorine measured readings with DPD reagent or test	Before the reading drops below this level, the use of the Spa is forbidden paper
5.0	Recommended security level
4.0	by DPD reagents
3.0	
2.0	Adding chlorine
1.0	Adding chlorine during the use of the Spa is forbidden
0	

Superchlorine

Superchlorination applies specially for burning" the accumulated chloramine (waste chlorine) to eliminate the chlorine odor and keep the free chlorine to a proper level. When conducting the water superchlorination treatment, please open at least a half of spa cover, in order to facilitate the chlorine emission. Superchlorination (non-daily disinfection) may lead to a too high chlorine concentration resulting in discoloration or degradation of the cover back. Such damage is not covered under the warranty.

⚠Warning: don't let the spa in unattended status, especially when children are present!

Water treatment guidelines	
When starting Spa or adding water	Follow the instructions of the section "Start and adding water procedures".
Before each use (Please test before adding any chemicals: if you find that the content of the chemicals is correctly or higher, don't add any chemicals)	Add ½ tablespoon of sodium bichloride to every 950 liters (250 gallons) of water or 1 tablespoon of monopersulfate to every 950 liters of water.
Once a week	Add 1.5 tablespoon of sodium bichloride to every 950 liters of water or 3 tablespoon of monopersulfate to every 250 liters of water.
Every four months	Drain the water completely; replace minerals filter core and re-adding water according to the instructions in the section "Start and re-adding water procedures".
When necessary (If the water becomes turbid has or peculiar smell	Add 1.5 tablepoon of sodium bichloride to every 950 liters of water.

Water quality and maintenance

Make daily disinfection plan

In the first month of use, please measure the residual amount of disinfectant every day, in order to determine the demand standard of the filtercore and disinfectants according to different frequency and time of use.

- Use frequency: refers to the person-time entering into a spa.
- Use time: refers only to the use time of a single person.
- Disinfectant demand refers to the quantity of disinfectants required by user number and total use time.
- For example, two persons regularly use the spa, one time per night and 20 minutes each time. In this case, the disinfectant demand is relatively clear and generally fixed. In the first month of use, the two users can accurately determine the required quantity of disinfectants to maintain proper residual chlorine. If the use frequency/use mode changes greatly in a certain period of time (for example inviting guests), then the disinfectant demand and frequency of adding disinfectant will greatly increase. The longer the use time and the more the use frequency is, the faster the residual chlorine value reduces.

Precautions

- Check the content of bromine disinfectants before each use;
- Replace the FROG minerals filter core once every four months.
- Test the total alkalinity and pH value once a week; Use only the non-chlorine (monopersulfate) oxidant.
- All chemicals must be sealed and placed in a cool and dry place and lead to losing efficacy of the disinfectants.
- Use of water purifying agent is forbidden, as it can cause water turbidity.

Water quality maintenance supplementary program

In a complete water maintenance program, proper water quality hygiene and minerals balance (pH value control) is essential. There are another three optional common additives for the water treatment as follows: Mineral deposition inhibitor

- With the water evaporation and adding fresh water, the amount of dissolved minerals will increase. (Cover the spa as much as possible to minimize water evaporation.) Water will eventually become "hard" (calcium hardness is too high) to lead to damaging the heater surface due to calcification. Proper pH value control can minimize this possibility.
- Under normal circumstances, the soap will be piled up more and more. Therefore, it is necessary to replace the water regularly. The mineral deposition is usually not a problem
- Sometimes, the content of iron and copper in the water is higher and this may produce green and brown spots on the spa tub. In this case, detergents may help to reduce these metals.

Note: the content of minerals in the well water is higher. A low flow water filter with ultrafine pores can help filter out many of the larger particles.

Foam inhibitors

- Because the soap will be piled more and more in the water, so the water needs to be replaced. Generally, when using nozzles, the soap can cause foaming of the water. Soap comes into the spa in two ways: the user's body (residual soap after the shower) and swimwear (residual soap after washing).
- Foam inhibitors can inhibit foams, but can not eliminate the existing foams from the water. Soap can never be oxidized by chemicals added to the water and is therefore difficult to be removed from the water. Only ozone can oxidize soap.
- At last, soap will accumulate to higher concentrations in the water and lead to skin discomfort of the users. This is impossible to remedy. In this case, please drain out the water and fill fresh water into the spa. Freshwater should be able to be used for four months, but depending on the input amount of soap.

Ozone system

- Ozone system is the ozone purification system installed after license on the spa. Efficient ozone system uses "corona discharge" (CD) technology. Compared with the same kind of ultraviolet (UV) ozone systems, it is capable of producing higher concentrations of ozone.
- This efficient ozone system uses hidden installation, not only more subtle, but also not easy to be influenced by the eezing temperature. When servicing ozone system, please remove the door of the equipment cabin and check the operation of the equipment (usually, this operation should be carried out before disconnecting power of the spa to draining water). As long as you hear the hum of the transformer, you can determine that the efficient ozone system is working properly.
- As a complement measure to the regular maintenance of water quality program, Efficient ozone system can greatly improve water quality. In contrast with some wording about the ozone system from mouth to mouth by some people in the swimming pool and spa industry, ozone can not be used along for disinfection, water purification, anti-foaming and chelating minerals. SUNRANS recommends, if you ensure the water hygiene and the highest quality of purified water by using ozone purification system, you should still develop a chemicals maintenance program accordance with the written and accepted standard in the industry and comply with it.

Water quality and maintenance

Clean of the ozone nozzle

Sometimes, the ozone nozzle can be blocked due to mineral accumulation, that will lead to interruption of the ozone bubble flow or lower speed of the ozone bubble flow. In order to prevent this situation, please clean the nozzles in according to the following instructions:

- Cut off the power of the spa.
- Open the equipment cabin.
- Take a container (such as a bowl or bucket), pour 0.5 liters of white vinegar into the container, and then place the container on the floor of the equipment compartment. Note: white vinegar will not damage any part of the spa
- Carefully loosen the long transparent hose connected to the ozone generator bottom. There may be some liquid in the hose. If so, please don't touch this liquid. You should insert one hose end into the white vinegar, until it touches the bottom of the container.
- Reconnect the spa power.
- Start the spa, until all 0.5 liters of white vinegar is completely pumped. This allows enough white vinegar to flow through the nozzle and clear the blockage.
- Cut off the power of the spa.
- Take out the empty container.
- Reconnect the hose to the bottom of the ozone generator.
- Close the equipment cabin door.
- Reconnect the spa power.

Ozone system is located inside the equipment cabin and needs almost no maintenance. But when bubbles appear in the backwater of the heater and the water is not as clear before, you need to check whether the ozone generator works properly. Carefully open the equipment cabin door (please be careful, because the spa is still powered) and confirm the normal operation of CD tube and its transformer (ozone generator housing will make a slight hum). If you don't hear the slight hum, please confirm that the generator has been connected fully with the control box of the spa.

⚠Warning: if the fault to be treated is beyond the scope of this manual, please contact dealers. Ozone system can be repaired only by qualified technicians. Important note: ozone nozzle cleaning does not belong to the warranty scope. Please refer to the above mentioned ozone nozzle cleaning instructions.

Precautions

- The use of acid and hydrochloric acid to reduce the pH value of the swimming pool is forbidden.
 - It is forbidden to splash the pH value increasing agent into the wall.
 - The use of solid disinfectant is forbidden.
 - It has now proved that the use of flotation devices containing bromine sticks or bromine flake may cause discoloration or damage of the tub surface, because the floating device may fall into the bottom cabin or chairs (or sink to the spa bottom).
 - Although the floating disinfection system is a low-maintenance or even maintenance-free solution, but it is not suitable for the spa maintenance program.
- for the spa maintenance program.
- Spa tub can easily resist the influence of correctly distributed disinfectants. Non-floating dispensers could be concentrated in one area leading to excessive disinfection in this area (or chemical burn).
- If the position of the dispensers is too high, the high concentration disinfectant can lead to discoloration of the spa tub and damage to the cover back.
- Because of the extremely large change of the decomposition speed of chemicals great, the automatic floating dispensers could result in insufficient or excessive bromide and lead to quick damage to the spa tub and cover.
- Important note: Recommends not using any floating dispenser. The damage to the spa tub or parts caused by the floating dispensers belongs not to the limited warranty range.
- All chemicals must be added slowly to the filtration cabin or before filtration cabin and let the jet pump run 10 minutes in the same time.
 - Please be particularly careful by cleaning the inner and outer plastic surfaces with baking soda. The use of non-specific spa disinfectant is forbidden.
 - The use of household bleach (sodium hypochlorite solution) is forbidden.
 - Spraying chemicals onto the water surface is forbidden. This method will cause bubbling on the tub surface because the chemical reaction (chemical misuse).
 - It is forbidden to use the granular bromine disinfectant together with ozone.

Water quality and maintenance

General problems about the water chemical properties

Question: Why do you not recommend the water disinfection with the floating device?

Answer: Does not recommend the floating disinfection with the floating device for three reasons:

- the floating device is unable to control the speed of the disinfectant dissolved in water. When the floating device has just been placed in a spa, the concentration of the disinfectant could be extremely high and lead to chemical burns or discoloration on the spa tub or cover back. After some time, the concentration of disinfectants distributed through the flotation device will drop almost to zero. Low concentration of disinfectants will not inhibit the growth of virus, bacteria or algae.
- Floating devices shall be sometimes concentrated in an area (typically stay on chairs) and lead to damage to this area due to the contact with the disinfectants with a high concentration.
- The disinfectants with a high concentration could splash from the floating devices and fall onto the floor or base of the spa. The disinfectants could lead to chemical burning (bubbling) on the spa tub. The spa tub is specifically designed and is able to withstand the influence of chemicals, but no spa surface can bear the highly concentrated chemicals. Please remember, the misuse of chemicals is especially not covered by the warranty range.

Question: When smelling the chlorine odor by opening the spa cover, how to remove it?

Answer: There are two forms of chlorine in the spa. The first one is free residual chlorine, which can be used for disinfection of the spa. This free residual chlorine is odorless. The second is chloramines, which is the residue of chlorine consumed. Chloramines have a strong chlorine odor. Through a water "oxidation treatment", you can eliminate the odor of chloramines. When the water has a chlorine odor, it means you need to add the oxidation agent.

QUESTION: Why is it not allowed to add the soft water to the spa?

ANSWER: Soft water and normal water is basically the same, but the calcium in the soft water is mostly (or even fully) replaced by sodium. Soft water may corrode the heater and other components. If a spa component was damaged by soft water, the replacement is very expensive.

QUESTION: I want my family to touch chemicals as less as possible. So many kind and so large doses of chemicals are really needed?

ANSWER: More touching of any chemical is harmful to the human body. But many chemicals at lower concentration have a good function. For the spa water, chemicals recommended by CALDERA water quality maintenance program are required, in order to protect the users from hazards of aquatic pathogens (disease-causing microorganisms) while preventing corrosion of the spa components.

QUESTION: Why the chemical damage belongs not to warranty scope?

ANSWER: The water quality and the concentration of chemicals stay under your direct control. Through appropriate basic maintenance, the spa can provide you warm water wellness enjoyment for many years. If you have a lack of understanding of any chemicals and their use in the spa, you can contact company or authorized dealer.

Terms related to water

In the "Water quality and maintenance" section, following terms are used. Understand its meaning will help you better understand water quality maintenance measures.

Bromamine: the compound produced by the combination of bromine with nitrogen from skin oil, urine and sweat. Different from chloramine, bromamine has no irritating odor and is a highly effective disinfectant.

Bromine: halogen disinfectant (the same kind of chemistry with chlorine). Bromine is usually made in the form of rods, or flakes granules.

Calcium hardness: the content of calcium dissolved in water in the spa. Calcium hardness should be 150-200ppm. If the calcium content is too high, this will cause turbidity and scaling of the water. If its content is too low, this will cause damage to the spa equipment.

Chloramine: the compound produced by the combination of chlorine with nitrogen from skin oil, urine and sweat.

Chloramine can irritate the eyes and has a strong odor. Different from bromamine, chloramine is a weaker effect and slow functional disinfectant.

Chlorine: an high efficient spa- disinfectant. Recommends using Sodium bichloride in particulate form, because it can be completely dissolved and closes to neutral PH value, and therefore it is best to use sodium bichloride particles.

Residual chlorine (or residual bromine): refers to the residual amount of chlorine or bromine, after the demand of chlorine or bromine has been satisfied. Thus, the residual amount is the amount of chemical disinfectants that can be used to kill bacteria, germs and algae.

Water quality and maintenance

Corrosion: refers usually to gradually damaging to metal parts of the spa due to chemical reaction. Under normal circumstances, the correction can happen, if PH value is low, or the level of TA, CH, PH value and disinfectants exceeds the recommended range.

DPD: refers to the optimal reagent using for free residual chlorine measurement.

Halogen: one of the five elements fluorine, chlorine, bromine, iodine and astatine.

MPS: monopersulfate, which is a chlorine-free oxidant.

Pathogens: refers to microorganisms such as pathogenic bacteria.

PH value: refers to the measuring value of water acidity. Recommended PH value is 7.2-7.6. When the PH value is less than 7.0 (neutral value), the water acidity is greater and this will damage the heating system. When the PH value is higher than 7.8, the water alkaline is too large, and this results in water turbidity and scaling on the tub surface housing and heater.

PPM: abbreviation of millionth, the measurement standard unit of the chemical content in the water, equal to "mg/l" (mg/liter).

Reagent: refers to chemicals for chemical testing in liquid, powder or flake form.

Disinfectant: refers to disinfectants that have been added and maintain the recommended residual amount. They are used to protect bathers against the damage from pathogenic organisms, which can cause disease and infection of the spa water.

Scale: refers to coarse sediments containing calcium that cover the spa tub surface, heater and water pipes or block filter. In general, if the water contains minerals and has a high PH value, the scale will be formed. In addition, scale can be formed more easily at higher water temperature.

Oxidation treatment: when using chlorine, it is also known as "super-chlorination treatment." Oxidation treatment refers to add a large dose of instant disinfectant (recommend using "sodium bichloride") to remove chloramines and bromide by the oxidation of organic waste that can be not filtered out.

Total alkalinity: refers to the amount of heavy carbonate, carbonates and hydroxides in the spa water. A proper total alkalinity is very important for PH value control. If the total alkalinity is too high,

it is difficult to adjust the PH value. If the total alkalinity is

too low, the PH value is difficult to maintain at an appropriate level. The ideal range of total alkalinity in the spa water is 125-150ppm.

Guide for problem solution in Spa water quality

Guide for problem solution in Spa water quality maintenance

Guide for problem solving in Spa water

Error	Possible reason	Solutions
Water turbidity	<ul style="list-style-type: none"> ● Filter dirty ● Greasy organic matter too much ● Mproper disinfection, ● Particulate/organic matter too much <p>Too often with too much water or too long</p>	<ul style="list-style-type: none"> ● Clean the filter ● Carry out oxidation treatment to Spa with disinfectants ● Add disinfectant ● Adjust the PH value and/oralkalinity to the recommended range ● Start jet pump and dean the filter ● Drain out the water and re-add water
Stinking water	<ul style="list-style-type: none"> ● Organic matter in water too much ● Improper disinfection ● PH value is low 	<ul style="list-style-type: none"> ● Carry out a oxidation treatment to the spa with disinfectant ● Add disinfectant ● Adjust the PH value to the recommended range
Chlorine odor	<ul style="list-style-type: none"> ● Chloramine content is too high ● PH value is low 	<ul style="list-style-type: none"> ● Carry out a oxidation treatment to the spa with disinfectant, ● Adjust the PH value to the recommended range
musty odor	<ul style="list-style-type: none"> ● Bacteria or algae Growth 	<ul style="list-style-type: none"> ● Carry out a oxidation treatment to the spa with disinfectant. If the problem persists, please drain out water, dean the spa and add new water ● Clean scum with a dean doth—if the problem is serious, drain out water, remove scum with deaning agent for Spa surface and ceramic tiles, and then add water again.
Accumulation of organic matter around the spa/scum	<ul style="list-style-type: none"> ● Grease and dirt Accumulation 	<ul style="list-style-type: none"> ● Carry out an oxidation treatment with disinfectant to oxidation treatment to the Spa and adjust the PH Value
Algae growth	<ul style="list-style-type: none"> ● High PH value ● Low concentration of the disinfectant 	<ul style="list-style-type: none"> ● Carry out a oxidation treatment with disinfectant to oxidation treatment to the Spa and maintain appropriate disinfectant concentration ● Adjust the PH value
Irritating to eyes	<ul style="list-style-type: none"> ● Irritating to eyes ● Low concentration of the disinfectant 	<ul style="list-style-type: none"> ● Carry out a oxidation treatment with disinfectant to oxidation treatment to the Spa and maintain appropriate disinfectant concentration ● Adjust the PH value. Carry out a oxidation treatment with disinfectant to oxidation treatment to the spa and maintain appropriate disinfectant concentration.
Skin allergies /skin rash	<ul style="list-style-type: none"> ● Unhealthy water ● Free residual chlorine concentration is higher than 5ppm 	<ul style="list-style-type: none"> ● Before using spa, lower the free residual chlorine concentration to 5ppm or less.
Taints	<ul style="list-style-type: none"> ● Total alkalinity and/or PH value is too low ● Content of iron and copper in tap water is higher 	<ul style="list-style-type: none"> ● Adjust the total alkalinity and/or PH value ● Use metal deposit inhibitors
Scaling	<ul style="list-style-type: none"> ● Calcium content in the water is higher, total alkalinity and PH value is too high 	<ul style="list-style-type: none"> ● Adjust the total alkalinity and/or PH values - if need to remove deposits, drain out water, dean fouling, adjust total alkalinity and PH value after - readding water

Spa problem solution

If your Spa seems not to work properly, please refer to the "Start" and "Operation" instructions in this manual. If this does not help you solve the problem, please follow the following instructions. If you still can't resolve the problem, please contact your dealer.

Guide for troubleshooting in general operations		
Evolutions	Possible	Solutions
Entire spa does not work	<ul style="list-style-type: none"> ● Power failure ● GFCI tripped ● Heater overheat protection temperatureswitch tripped ● Spa lock is opened 	<ul style="list-style-type: none"> ● Check the power ● Reset the GFCI. If it can be not reset please call the service personnel ● Disconnect the power for at least 30 seconds reset heater overheat protection switch. If it can be not reset, please check whether the filter is dogged. If the switch still trips, please call the service personnel ● Stop using the spa lock
Weakness or intermitten! Injection	<ul style="list-style-type: none"> ● Water level is too low ● The filter is dogged ● Air valve is dosed ● Spa lock is opened 	<ul style="list-style-type: none"> ● Add water ● Clean the filter ● Open the air valve ● Stop using spa lock ● Call service personnel
All the lights don't shine	<ul style="list-style-type: none"> ● Connection or interface failure between 	<ul style="list-style-type: none"> ● Remove the panel, reconnect the LED lights with fiber bundles. If the light still does not shine, call service Personnel
All the lights don't shine	<ul style="list-style-type: none"> ● the light and the control box ● Lamp wiring fail 	<ul style="list-style-type: none"> ● Clean the filter ● See the "Start" section in this manual ● Disconnect the power for at least 30 seconds. If the indicator continues to flash after powering, call service Personnel
Indicator light "Power and ready" is blinking	<ul style="list-style-type: none"> ● The main light device failure ● Lamp wiring is not connected to the fiber bundle ● Filter dirty ● The water level is too low ● The pressure switch has problem. ● Heater overheat protection temperature switch tripped 	<ul style="list-style-type: none"> ● Disconnect the power for at least 30 seconds, reset Protection switch. If the switch can be not reset, check whether the filter is dogged. If it still trips, call the service personnel ● Disconnect the power for at least 30 seconds. If the lights continue to flash after power on, call the service Personnel
Indicator light "Ready" flashes	<ul style="list-style-type: none"> ● Temperature sensor fault 	<ul style="list-style-type: none"> ● Set a higher temperature on the control panel
Spa can be not properly heated	<ul style="list-style-type: none"> ● The temperature setting is too low ● Spa cover is not in place ● The filter is dirty ● Summer timer is turned on ● Motor overloading ● If the nozzle symbol does not shine, it is a control switch malfunction 	<ul style="list-style-type: none"> ● Align Spa cover ● Clean the filter ● Switch the summer timer to the off position. ● Coding one hour. Motor overloading will automatically reset. If the problem persists, please contact your SUNRANS dealer
Jet pump motor does not work	<ul style="list-style-type: none"> ● Motor overloading ● If the nozzle symbol does not shine, it is a control switch malfunction 	<ul style="list-style-type: none"> ● Disconnect the power supply and contact your dealer. Add water to the normal level (2.5 cm or 1 inch above the highest nozzle). Open or clean air valves
Jet pump or motor noise is too high	<ul style="list-style-type: none"> ● Water level is too lower 	<ul style="list-style-type: none"> ● Disconnect the power supply and contact your dealer. Add water to the normal level (2.5 cm or 1 inch above the highest nozzle). Open or clean air valves
Jet pump motor runs, but Pressure re/injection	<ul style="list-style-type: none"> ● Air control valve dosed or dogged 	<ul style="list-style-type: none"> ● Open or clean air valves
Pressure is very low	<ul style="list-style-type: none"> ● Water level is too low ● The filter is dirty ● Nozzle dogged ● Filter net or filter basket dogged 	<ul style="list-style-type: none"> ● Add water to the normal level (2.5 cm or 1 inch above the highest nozzle) ● Clean the filter ● Remove the eyeball on the nozzle panel and clean the nozzle head ● Clean filter net cover or filter basket
Divert valve rotates difficult	<ul style="list-style-type: none"> ● Sand deposits in valves ● Jet pump does not start properly. 	<ul style="list-style-type: none"> ● Clean and lubricate the diverter valve in accordance with the diverter valve maintenance instructions ● Shut off the power on circuit breaker and remove the equipment cabin door (see "spa drain" section) ● Loosen the joint on jet pump top (see "Winter preparation"), so that air can enter, then tighten the joint with hand. ● Restore power for spa, start the jet pump, check and make sure that the joint is closed to prevent leakage. Replace the equipment cabin door, or: remove and re-install the filter cap.
After filling or adding water, a jet pump works properly, but all nozzles spray no water.		

Start water pump: by adding or replacing the water, if the pump is operating but no water flows out from any nozzle, this indicates that the pump may not start properly. To resolve this problem please refer to the above mentioned steps and operate according to the following procedures:

- Turn off the power of the Spa with the circuit breaker and remove the equipment cabin door.
- Loosen the joint on the pump top to discharge air, and tighten the joint again when water flows.
- Turn on the power, start the water pump and confirm that the joint was really tightened to prevent water leakage.

Service

Other service information

Control device and over heat protection temperature switch is equipped with a number of electronic sensors connected with spa pipes. The connection cables between sensors and the temperature switch in the control box may not be damaged or knotted.

The jet pump is equipped with a thermal overload circuit breaker to prevent overheating of the water pump. If the pump shuts itself down after the spa is used for some time, it may be a failure of the pump motor bearing. If the water pump shuts itself off by a new type spa, it is usually caused by one or more of the following factors

- Temperature overload: although it is a serial production, but the temperature overload switch is not exactly the same. Some of them are more sensitive and can dose the water pump at a lower temperature.
- High temperature: all models of the spa are equipped with a jet pump and the motor of the jet pump will generate heat. Your spa has an air outlet leading to outside of the equipment cabin to prevent the jet pump motor from overheating. If the outlet is blocked by debris or grass dippings, it could lead to overheating of the jet pump. After the jet pump motor has been sufficiently cooled down and the blockage has been removed, the jet pump can be restarted.
- Friction: the moving parts of a new pump are sometimes too tight, this can lead to friction heat. After a normal break:-in period, the pump temperature will be reduced.
- Improper connection: when an extended cable is used or the cable diameter in your home is too small, the voltage could be too low for the water pump. This can lead to an excessive current and heat. If the jet pump stops due to overheat, you must ensure a sufficient ventilation of the equipment cabin. Don't block the air vents at the bottom of the equipment cabin. If the jet pump also stops after use for some time, please contact a qualified service personnel.

Behaviors leading to invalid warranty

- The limited warranty will be invalid, if there are the improper installation, alteration, misuse or abuse of the spa or reparation by personnel who are not authorized by company . behaviors such as alteration of any parts or pipes, any electrical change as well as the installation of unapproved sanitation equipment, water purification equipment or heating system, that lead to the promotion of component failure, main equipment failure or unsafe working conditions, are defined for the alteration.
 - Misuse and abuse should include that the spa is not operated or used in a non-specified location according to instructions printed by company, detailed including: use of the spa in the non-residential applications; the damage because of the operation of the spa beyond the water temperature range 1.5 °C(35 ° F) to 49°C (120 ° F) will let the limited warranty invalid.
 - Damage caused by dirty filters, blocking or scaling, the surface damage of the spa caused the use of trichloroisocynurate, bromochlorohydantoin (BCDMH), misuse of chemical tablets in floating devices, acid and any other company recommended spa surface chemicals or spa tub surface deaning agents and cause damage will let the limited warranty invalid.
 - Damage caused by the attachment of the insoluble spa disinfectants on the spa tub surface (no spa tub surface material can withstand this kind of abuse) and the damage of the components or the spa tub surface due to improper water chemistry maintenance will let the limited warranty invalid.
 - The damage of the spa tub surface caused by direct sun exposure without water and tub cover (in warm climate regions, this might involve the solar heating) will let the limited warranty invalid. All such cases are treated as abuse.
- ⚠ Warning: operating a spa does not mean "using" the spa! Recommends not to use the spa, when the water level is above or below the temperature range of the control panel.

Disclaimer

- For the loss resulting from the use of the spa or other incidental, consequential, special, indirect, or punitive costs, expenses or damages, including but not limited to remove permanent platform, other customized fixtures or requirement on the crane for removing work, Company shall be not liable. Any implied warranty period is equal to the above applicable warranty period.
- Some states (or countries) don't allow to make a duration limit for the implied warranty. For any personal injury or property damage, for whatever cause, and regardless of the circumstances, Company and its rep resentatives shall be not be responsib Wa m tip: some countries or regions do not allow the exclusion or limitation of incidental or consequential damages, so the above limitations may not apply to you.

Customer service

- If you have any questions in the installation, opeeration or maintenance of the spa that this manual does not answer, please consult the dealer. Declaration: our company reserves the right to modify the product without notice.

Guide for operation system instructions

Due to the different configuration parameters of the spa you have purchased, the control panel and control system of your spa also has certain difference, detailed please refer to the control system instructions attached to this User'manual.

Operating instructions of control system panel (see attachment of User's manual)

(The following are several typical kind)

- **Control Panel Collection:**



SpaTouch



TP800



TP600



VL801 D



VL400



VL260

Instructions of the control system (see attachment of User's manual) (The following are several typical kind)

- **Control Box:**
 - GSNS series;
 - BP Series;

